

2025

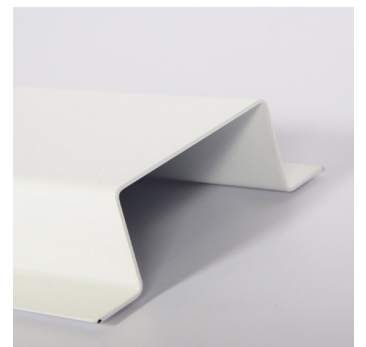

## CEILING SUSPENSION SYSTEMS | DATA SHEETS

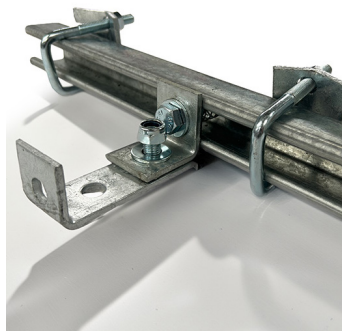
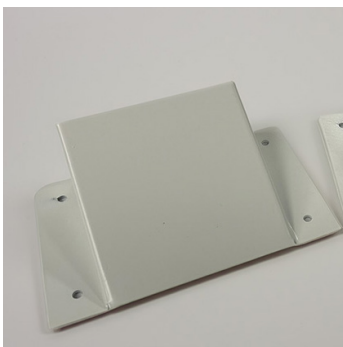

DOORS



METALS



SPARES



[spares.blusealdoors.co.uk](https://spares.blusealdoors.co.uk)



0845 00 66 777

## Introduction

Over the last 20 years, Bluseal have built a strong reputation for providing the very best in pre-sales and after-sales care. Whether it is a quick turnaround for an initial quotation or a speedy response to an emergency call-out, we always strive to offer every client, large or small, the complete customer experience.

We have carefully selected our sheet metal and parts suppliers to ensure that the quality of their products meets with our renowned high standards.

It is these standards coupled with our own in-house technical expertise that has led to Bluseal products being favoured by a number of architects and specialist consultants across a range of industries.



[G500 Series Ceiling Suspension](#) [Pages 4 - 5](#)

[E500 Series Ceiling Suspension](#) [Pages 6 - 7](#)

[F350 Series Ceiling Suspension](#) [Pages 8 - 10](#)

[PC500 Series Ceiling Suspension](#) [Pages 11 - 12](#)

[Top Hat Assembly Kit](#) [Pages 13](#)

[Fixings](#) [Pages 14](#)

[FAQs](#) [Pages 15](#)

## How to order:

Call:  
[0845 00 66 777](tel:0845 00 66 777)

Email:  
[metals@blusealdoors.com](mailto:metals@blusealdoors.com)

Or order online at:  
[spares.blusealdoors.co.uk](http://spares.blusealdoors.co.uk)

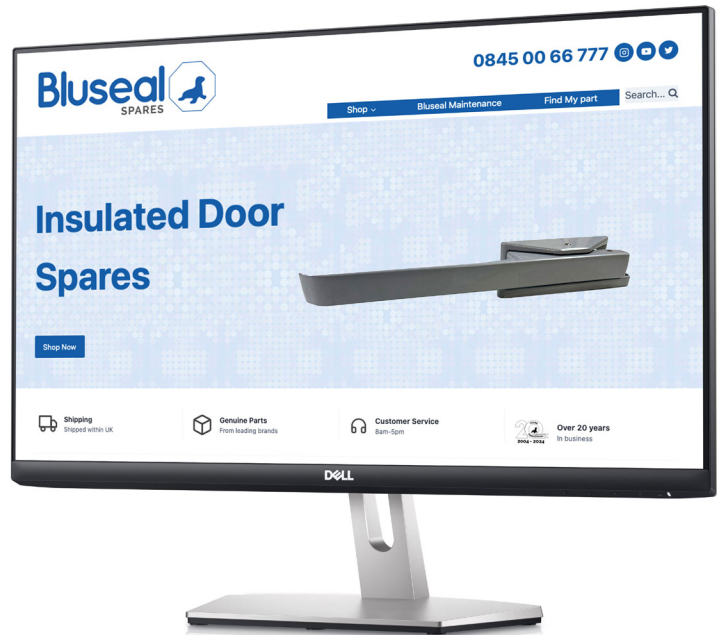



## The Seal of Approval

The Bluseal Ceiling Suspension Systems are a cost effective and safe solution to your suspended ceiling requirements, whether big or small we have the product you need.

All our systems are in-house designed, with our tophats manufactured using structural grade S280 galvanised steel to ensure a product you can trust. With all systems being externally strength tested aswell, to ensure maximum quality is achieved.

All our systems have been designed with ease of install in mind, from pre-assembled hanging bracketry to pre-cut PIR to suit your panel thickness, Bluseal Ceiling Suspension is a product you can trust at a competitive price.

From ambient requirements to chiller and freezer applications, Bluseal has the product to match.



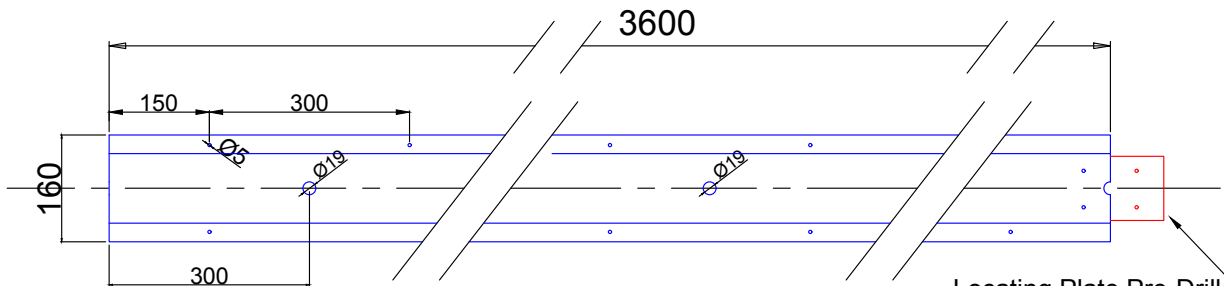

**F350 STARTER TOP-HAT**  
Ideal For Freezer Application

Locating Plate Pre-Drilled to Top-Hat with Matching Accurate Alignment Holes for On-Site Fixing. No Drilling Required

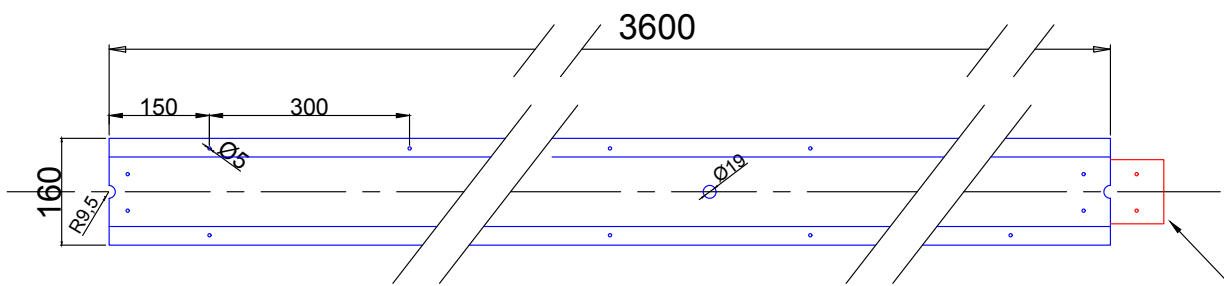

**F350 TOP-HAT**  
Ideal For Freezer Application

Locating Plate Pre-Drilled to Top-Hat with Matching Accurate Alignment Holes for On-Site Fixing. No Drilling Required

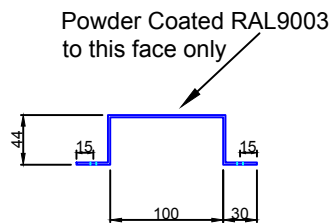

Section F350

[Order Part Online](#)



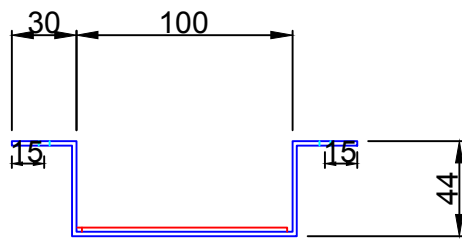
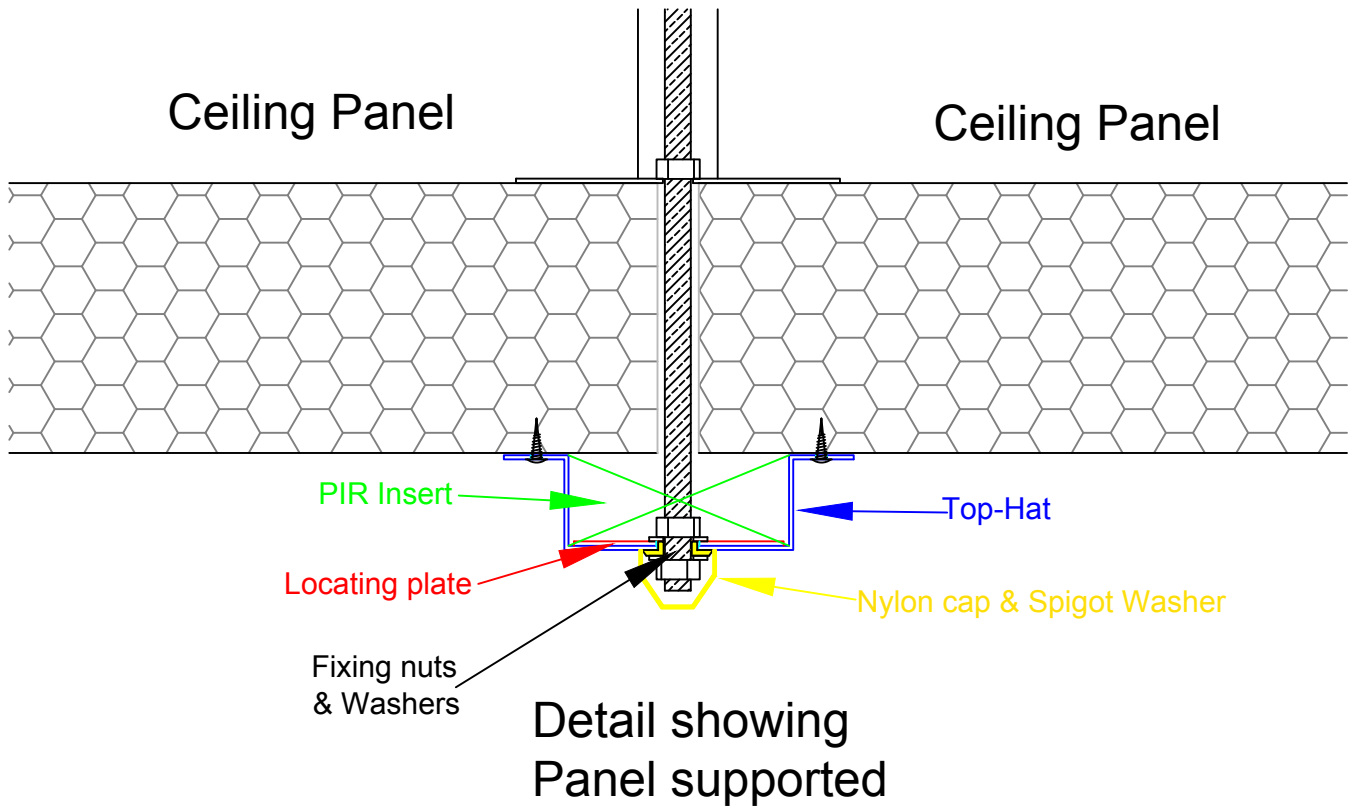

### Top-Hat Section

[Order Part Online](#)



### F350 AFS Fixing Kit detail

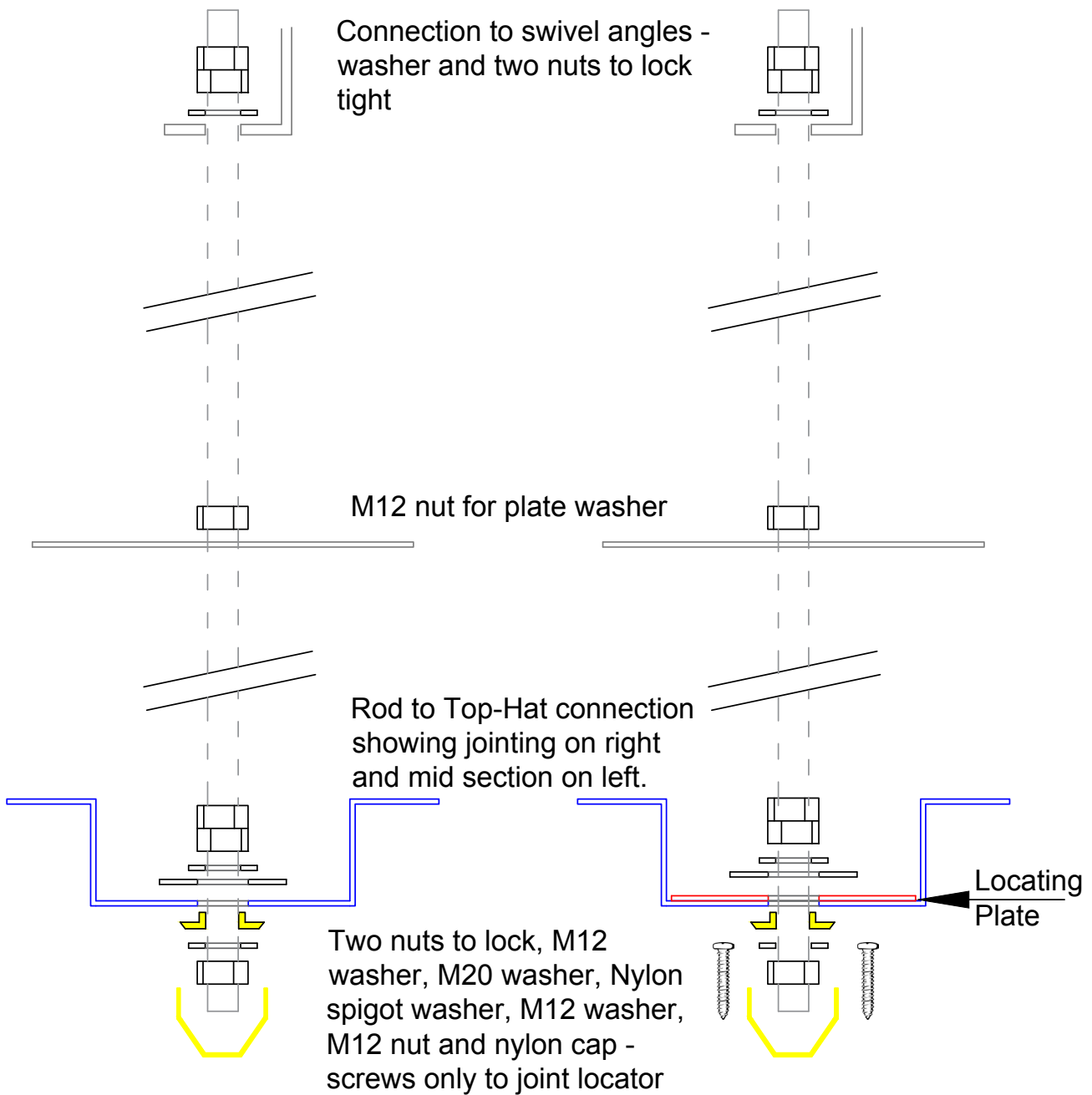

[Order Part Online](#)



## Top Hat Assembly Kit

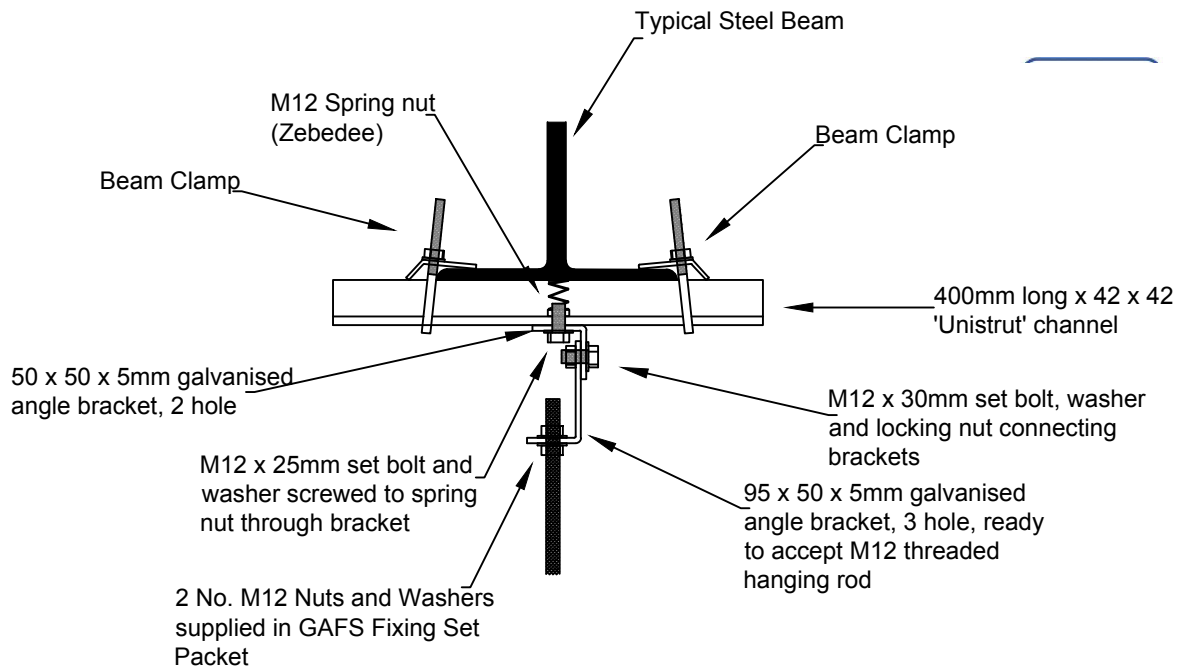

### 500A Detail

[Order Part Online](#)

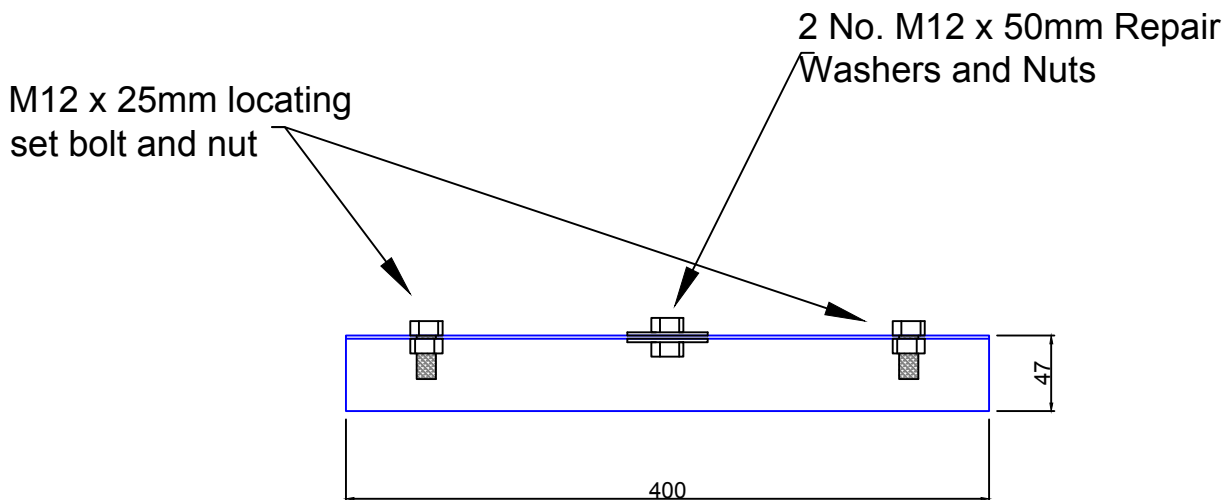

### 500 series joining detail

For use with G500 & E500 tophats only  
(fixings not included)



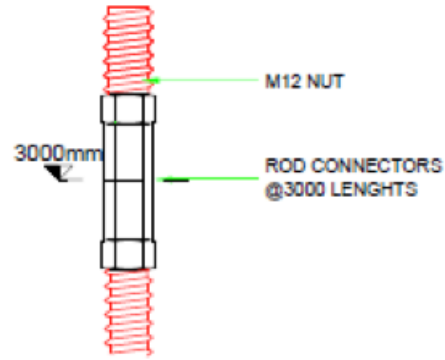

ROD CONNECTOR

Order Part Online



## SUSPENSION SYSTEM FAQ

### 1. What are your tophats made from?

We make the top hat sections for our ceiling suspension system from high quality S280 construction grade galvanised steel with 2mm thickness. This enables us to offer the same strength as other suppliers but in a thinner, lighter gauge material that is easier to handle on site.

### 2. What is the 500a/500z Kit and how do I put it together?

a. The Bluseal 500z kit is our beam clamp system where a straight drop from pre-existing steels is required. The Bluseal 500a kit is the swivel assembly beam system for attaching your drops to angled pre-existing steel and is suitable for where a straight drop is required.

b. No assembly of the beam clamps are required! Bluseal will supply you with a pre-assembled kit ready to install. There is no need to spend valuable time on site putting the pieces together, Just take from the box and fix to the steels!

### 3. What fixings do I need to get to fit the tophat to the drop rod?

a. Bluseal supply as standard, with all suspension systems, all the fixings that you need. With each tophat, you will have a pre-packaged bag that includes all of the nuts, washers and bolts you will need for all of the drops being used. This includes all the fixings needed to join tophat to tophat aswell!

### 4. Can I have the bottom capping in a different material and why is it 2m long?

a. Of course, we can supply this item in any material you want aslong as it is 0.7mm thick and under. We stock pre-made cappings in CS120 WFSL material but hold stock of 2m long material in 9010 Europoly aswell. Other colours available upon request to suit.

b. Bluseal primarily supply our bottom capping in 2m lengths for ease of handling and transportation. At 2m this becomes a one-man job and also helps to alleviate potential horseshoes/kinks that can occur via manual handling. However we are happy to supply this in 3m as well as 3.6m lengths upon request.

### 5. Do you supply PIR boards/Mineral Wool slabs for us to cut down on site?

a. Bluseal will supply pre-cut 1.2m lengths of your required infills for both inside the tophat and the void above it. If you tell Bluseal your panel thickness, then we will make sure we supply to suit. We can also obtain and supply full sheets of this material to use on site, but we can do the hard work for you!

### 6. I want to supply my own rod, nuts, and washers. Is this ok?

a. This is absolutely fine, on your point of enquiry please specify what you wish to be removed from the quote and we will do so. However, please note that this cannot be guaranteed by our test results. This only covers the suspension system If Bluseal supply the full kit. Any modifications made to the Bluseal system would void the test results.

### 7. I need my powdercoated tophats a different colour that Ral9003, can Bluseal help?

a. This isnt a problem at all, if you can provide us with the RAL or BS code required we can get a special batch manufactured and supplied for you!

### 8. Can I add flashings and ancillary items to my orders, or do I need to separate my enquires?

a. No need to separate your orders, Bluseal are your one stop shop and will more than happily combine orders to maximise deliveries. Saving you time and hassle dealing with one supplier!

b. We will even look to amalgamate door and door spares orders aswell, meaning you have a speedy all-in-one experience with Bluseal.



Scan the QR code.

 0845 00 66 777

 [spares.blusealdoors.co.uk](https://spares.blusealdoors.co.uk)

 [metals@blusealdoors.co.uk](mailto:metals@blusealdoors.co.uk)